



OPTO ENGINEERING

ILLUMINATOR DATA

LT4RTF100-30-1-W-24V

Lighting Dimension

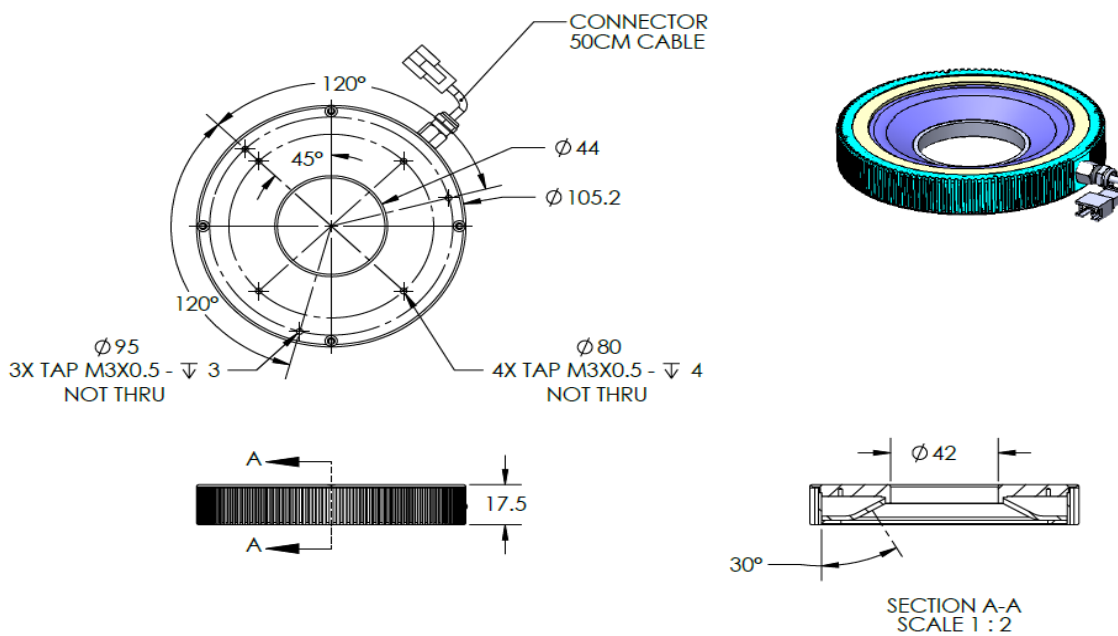

ROHS COMPLIANT CE

Mechanical Information

Casing Material	Aluminium
Storage Temperature Range	0 - 45°C
Storage Humidity Range	20 - 85%
Weight	230 g
Length / Outer Diameter	105.2 mm
Width / Inner Diameter	44 mm
Thickness / Height	17.5 mm



OPTO ENGINEERING

ILLUMINATOR DATA

LT4RTF100-30-1-W-24V

Lighting Information																							
Part Number	LT4RTF100-30-1-W-24V																						
LED Color	WHITE																						
Wavelength	REFER TO CHROMACITY TABLE																						
Working Distance	30 mm	40 mm	50 mm																				
Intensity (±15%)	TBA	TBA	TBA																				
Illumination (number of row)	1																						
Illumination Active Area	Active Length / Outer Dia.	95.8 mm																					
	Active Width / Inner Dia.	46 mm																					
Emission angle	30																						
Eye Safety Class (IEC62471)	EXEMPT																						
Chromaticity Table For White colour only	<table border="1"><tr><td>X</td><td>0.296</td><td>0.287</td><td>0.307</td><td>0.311</td></tr><tr><td>Y</td><td>0.276</td><td>0.295</td><td>0.315</td><td>0.294</td></tr></table>	X	0.296	0.287	0.307	0.311	Y	0.276	0.295	0.315	0.294	<table border="1"><tr><td>X</td><td>0.311</td><td>0.307</td><td>0.33</td><td>0.33</td></tr><tr><td>Y</td><td>0.294</td><td>0.315</td><td>0.339</td><td>0.318</td></tr></table>	X	0.311	0.307	0.33	0.33	Y	0.294	0.315	0.339	0.318	
X	0.296	0.287	0.307	0.311																			
Y	0.276	0.295	0.315	0.294																			
X	0.311	0.307	0.33	0.33																			
Y	0.294	0.315	0.339	0.318																			

Electrical Information	
Rated Constant Voltage	24V±2%
Rated Constant Current	225 mA
Power Consumption	5.4 W
Casing temperature, After 60 minutes operation	48 °C

Strobe Mode Specification	
*Normal Strobe Voltage	24 V
*Normal Strobe Current	225 mA
Overdrive Voltage Range	Min: 36V Max: 48V
Overdrive Current Range	Min: 5.4 A Max: 5.4 A
Recommended Overdrive Voltage	36V
**Max. Trigger Pulse Duration	10 msec
**Max. Duty Cycle	10%

*Normal strobe means the lighting is operated using the rated power. Overdrive means the power supplied to the lighting exceeded the rated power.

**Overdrive condition must not exceed the max. trigger pulse duration and max. duty cycle.

ILLUMINATOR DATA

LT4RTF100-30-1-W-24V

Connection Information			
Connector Type (Default)	JST SMR-03V		
Cable Length	50 cm		
Pin Configuration 	Pin	Signal	Cable Colour
	1	LED +	Red
	2	N.C	-
	3	LED -	White
			

Additional Information	
Additional Cooling Method	Attached to machine part for better heat dissipation
Intensity Controller Selection	SD, ST, ANG, LC, SDA, SDP series
CE Conformity	YES
RoHS Compliance	YES

Application	
Illumination Type	Diffused Illumination
Application Use	Printed Character on IC Chips, PCB Components Inspection, Printing on Caps and Wafer OCR Inspection.



OPTO ENGINEERING

ILLUMINATOR DATA

LT4RTF100-30-1-W-24V

Lighting Pattern				
Working Distance	For further details please contact us.			
Display and Image				
Data Results	Horizontal	Meas.(mm)	Vertical	Meas.(mm)
	90%		90%	
	80%		80%	
	70%		70%	
	60%		60%	
	50%		50%	
	40%		40%	
	30%		30%	
	20%		20%	
	10%		10%	